

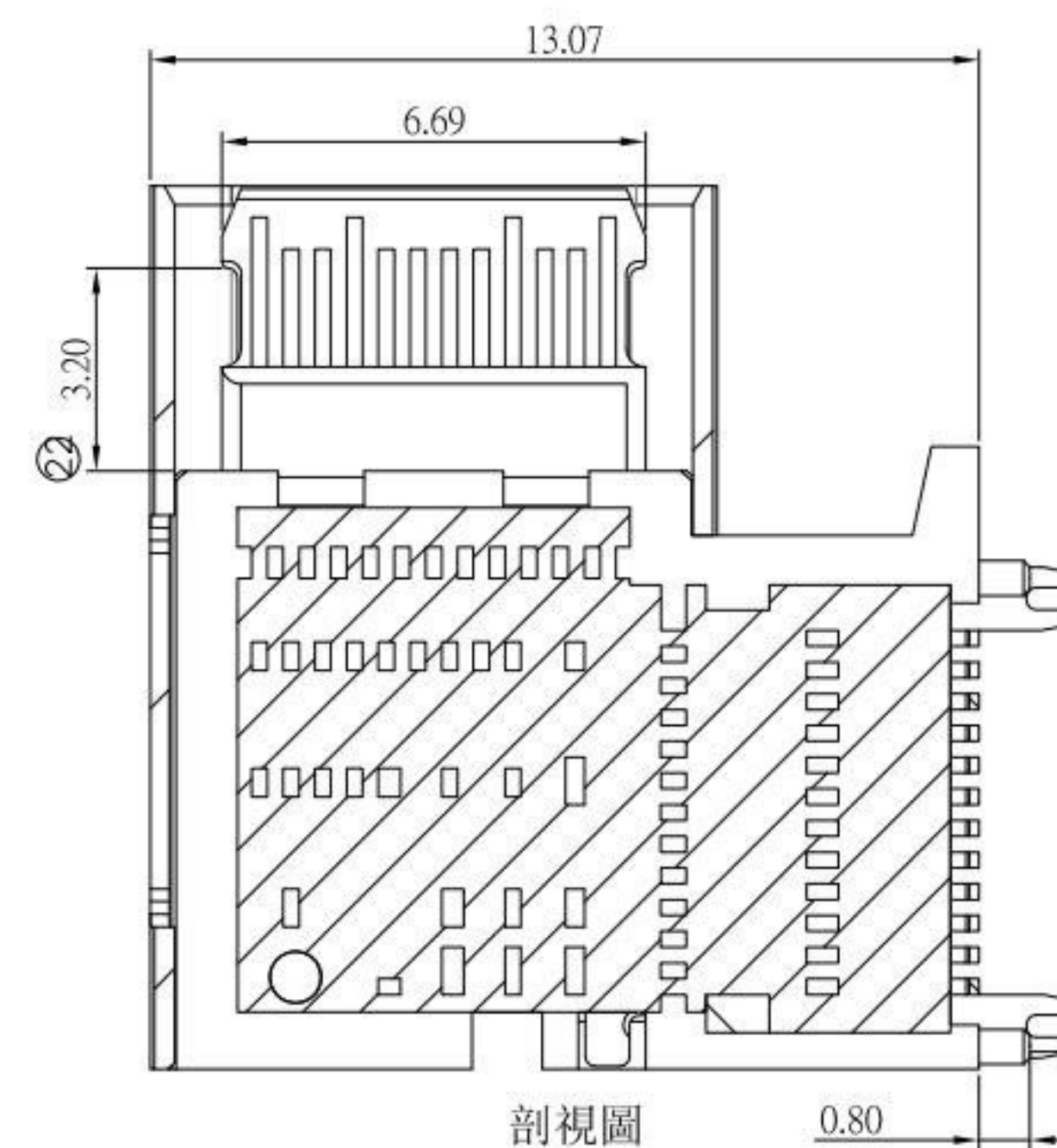

SBC-240P1-31x-S412

鍍層厚度:

- Blank : 1u"
- 2 : 15u"
- 3 : 30u"

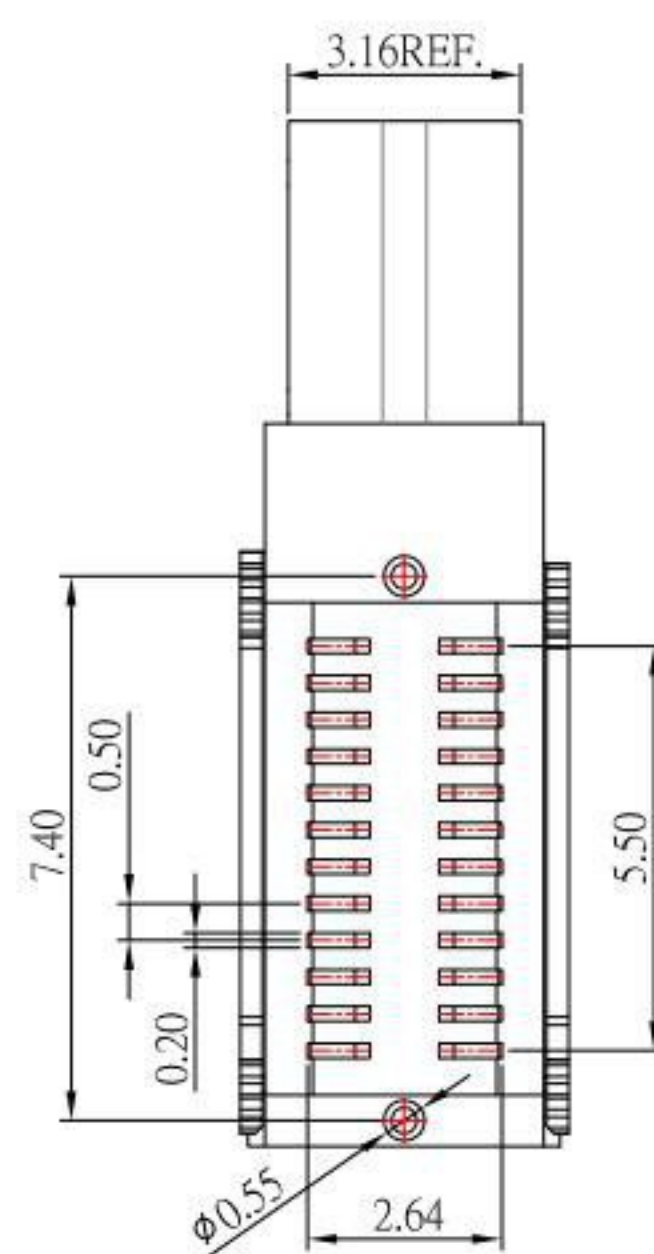
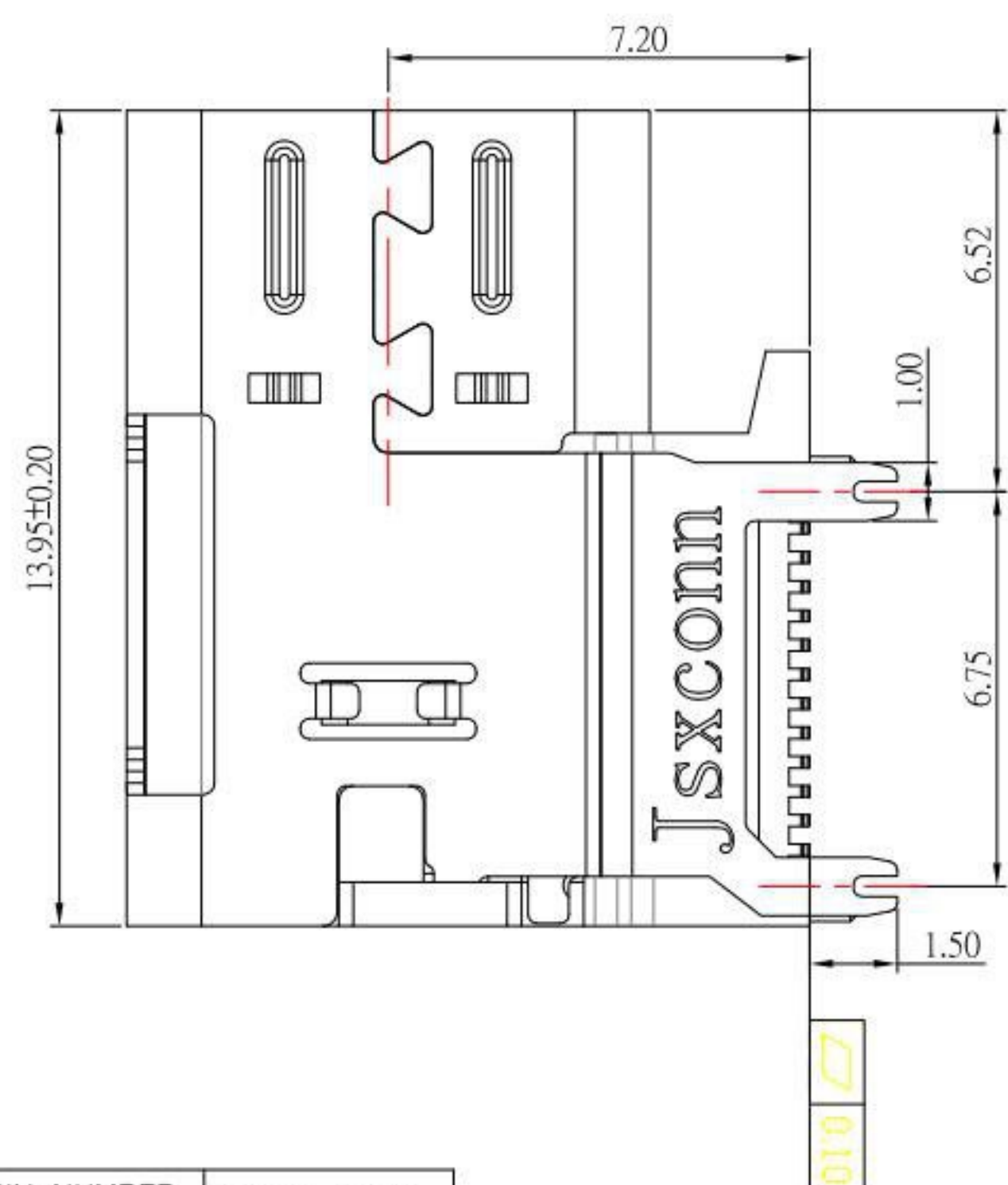
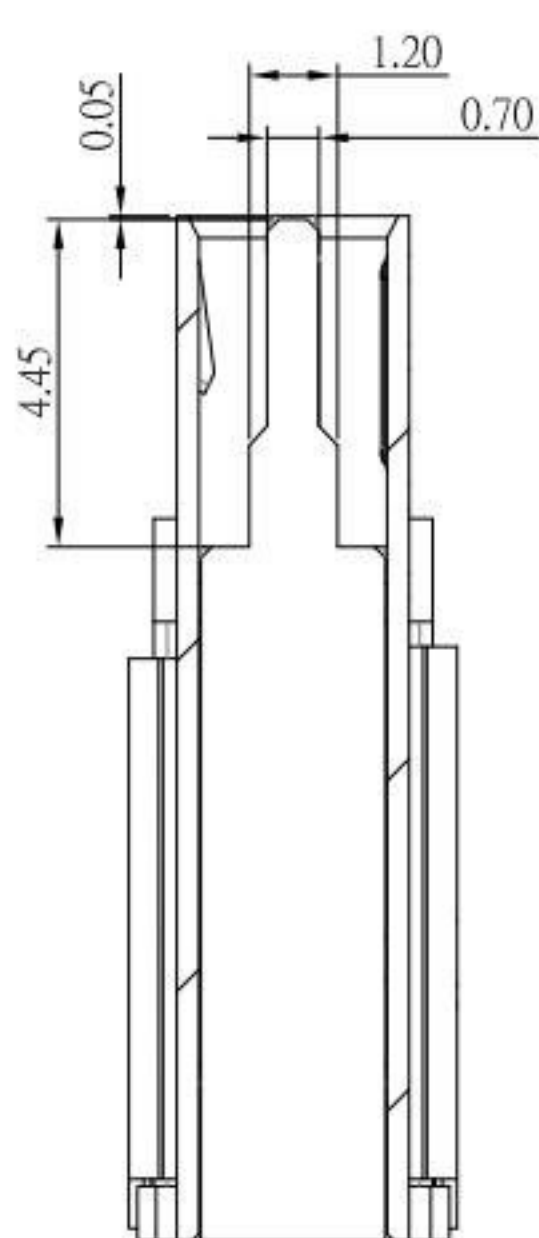
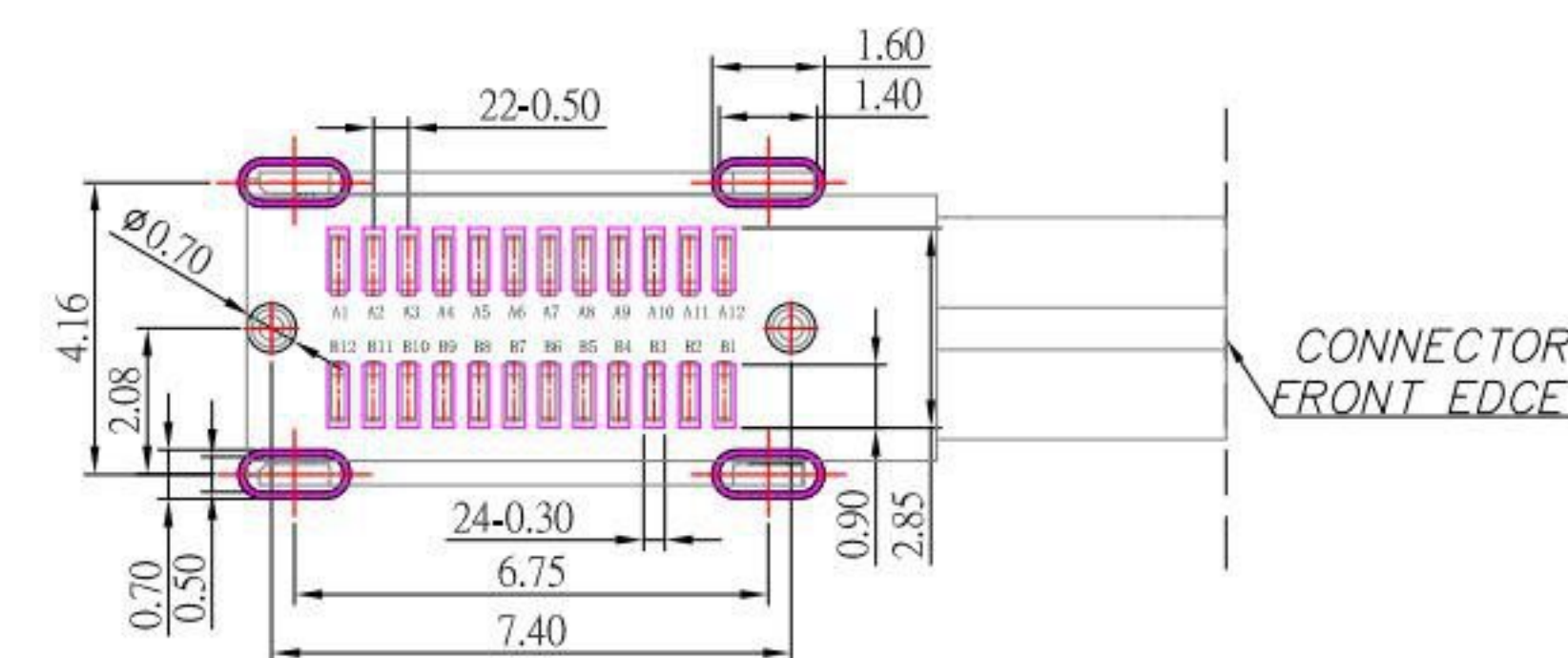
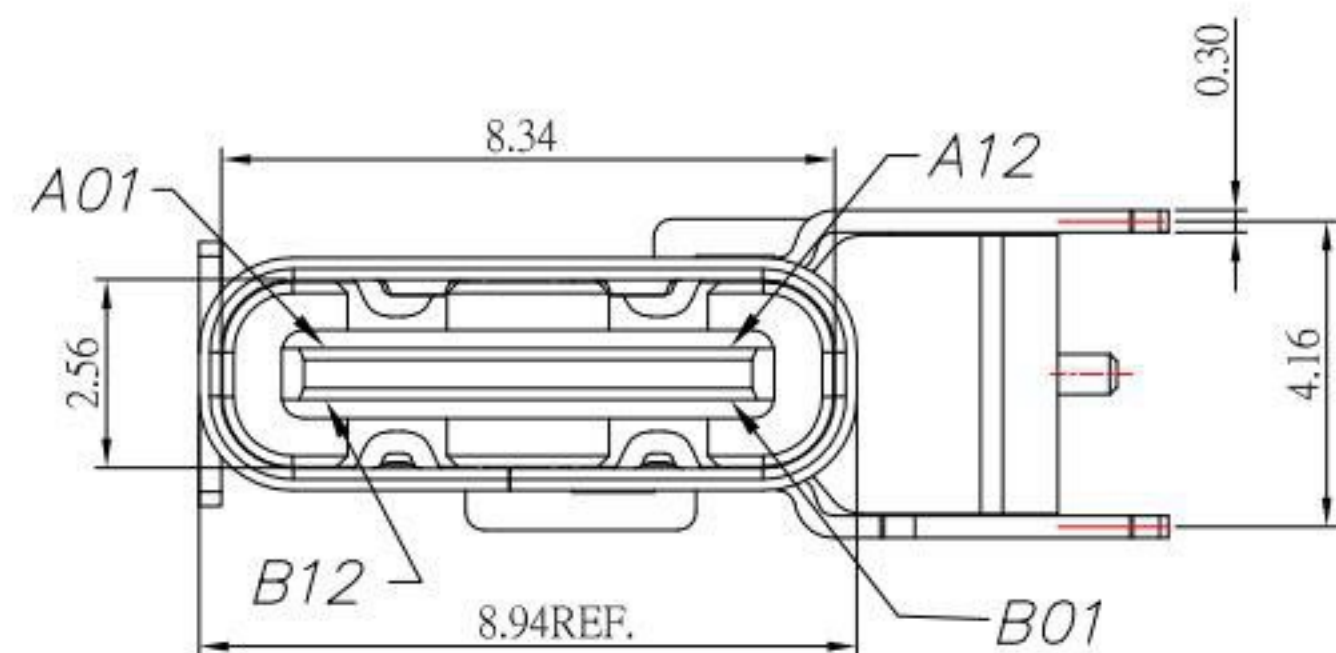
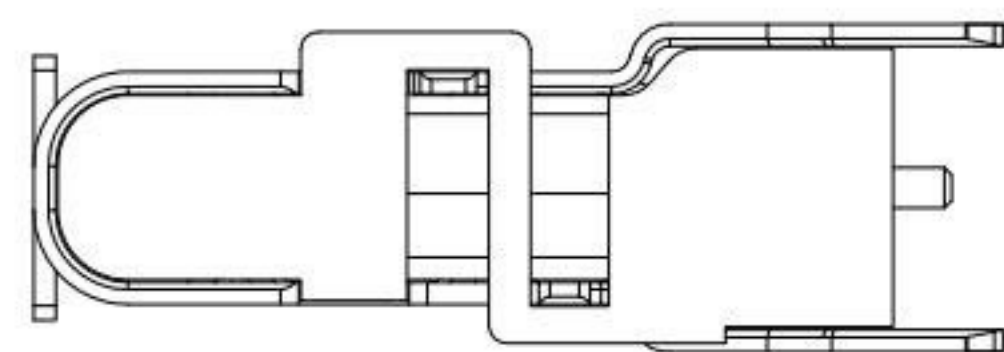

P.C.B LAYOUT MOUNTING PATTERN

SPECIFICATIONS

Electrical:

1. Rating: 5.0A
2. Contact Resistance: 40 mΩ Max
3. Insulation Resistance: 100 MΩ Min
4. Withstanding Voltage: 150V AC

Material:

1. Housing: LCP
2. Contact: C7025
3. Shell: SUS

Finish:

1. Contact: Plated Gold in Mating Area ;
Gold Plated on Solder Balls ;
Nickel under plated overall
2. Shell: Nickel under Plated surface layer

USB TYPE-C PIN ASSIGNMENTS

PIN NUMBER	SIGNAL NAME	PIN NUMBER	SIGNAL NAME
A1	GND	B12	GND
A2	SSTXp1	B11	SSRXp1
A3	SSTXn1	B10	SSRXn1
A4	Vbus	B9	Vbus
A5	CC1	B8	SBU2
A6	D+	B7	D-
A7	D-	B6	D+
A8	SBU1	B5	CC2
A9	Vbus	B4	Vbus
A10	SSRXn2	B3	SSTXn2
A11	SSRXp2	B2	SSTXp2
A12	GND	B1	GND

KSD 科斯达电子科技有限公司
 SWITCH CONNECTOR KSD ELECTRONIC TECHNOLOGY Co., LTD
 全球 互聯零組件 制造企业

TOLERANCE UNLESS OTHERWISE STATED:
 Up to 5 ±0.2
 Above 5 ~ 15 ±0.3
 Above 15 ~ 30 ±0.4
 Above 30 ~ 50 ±0.5
 Angle ±0.3°

3RD. ANGEL'S

UNITS MM

DRAWN BY:	DATE	MAT'L	TITLE	CONNECTOR
Jack Lu	02/23/23		MODLE	USB 3.1 TYPE C 24PIN 側貼CH7.2 SMT
CHECKED BY:	DATE	FINISH	DWG NO.	SBC-240P1-31x-S412
Jacky Chen	02/23/23		SHEET NO.	1 of 1
APPROVED BY:	DATE	SCALE	PART NO.	SBC-240P1-31x-S412
Tony Kao	02/23/23	1 : 1	SIZE	A4
			VER	R

ITEM NO.	DESCRIPTION	DRAWN	DATE