

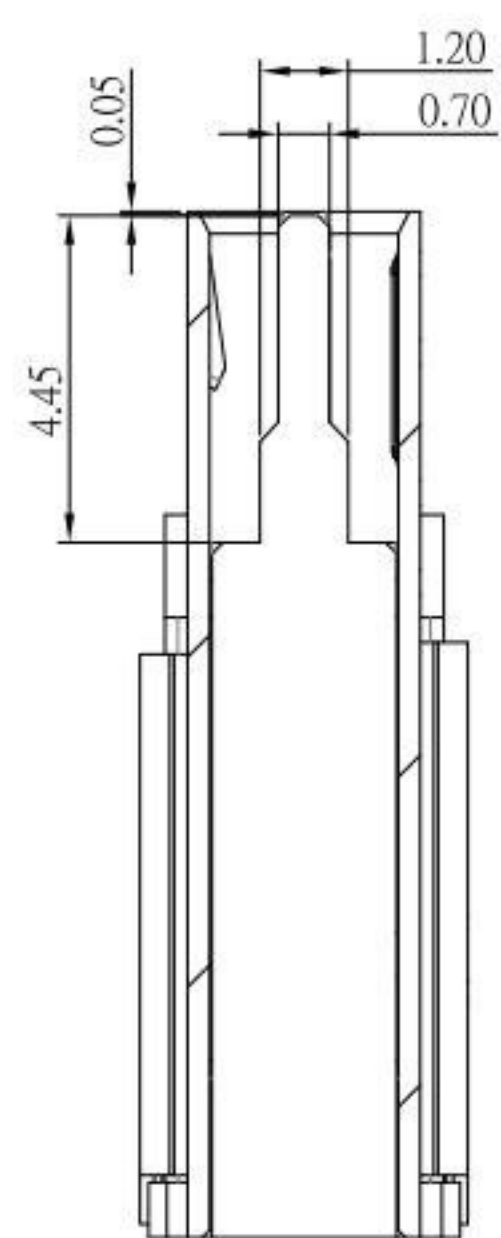

# SBC-240P2-31x-S412

鍍層厚度:

- Blank : 1u"
- 2 : 15u"
- 3 : 30u"

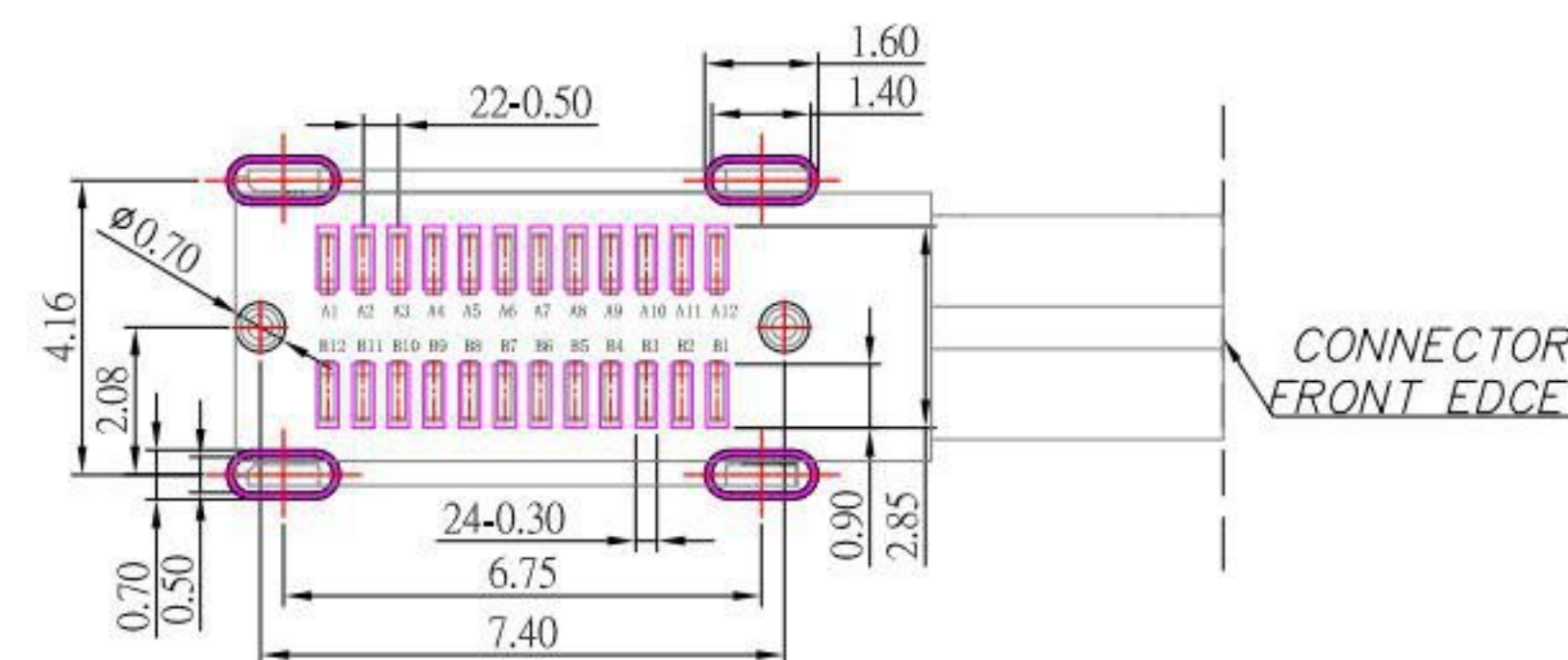
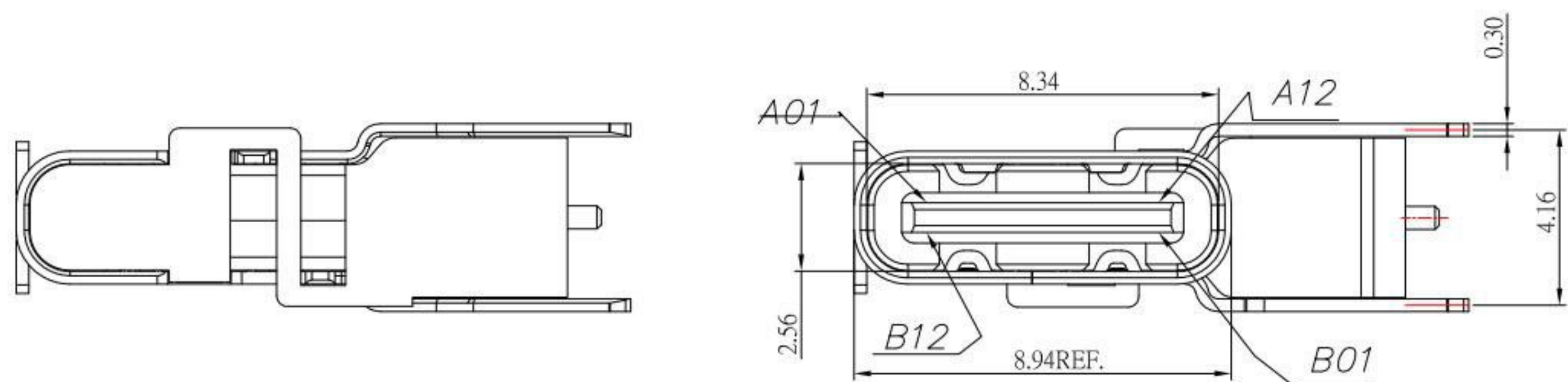

剖視圖

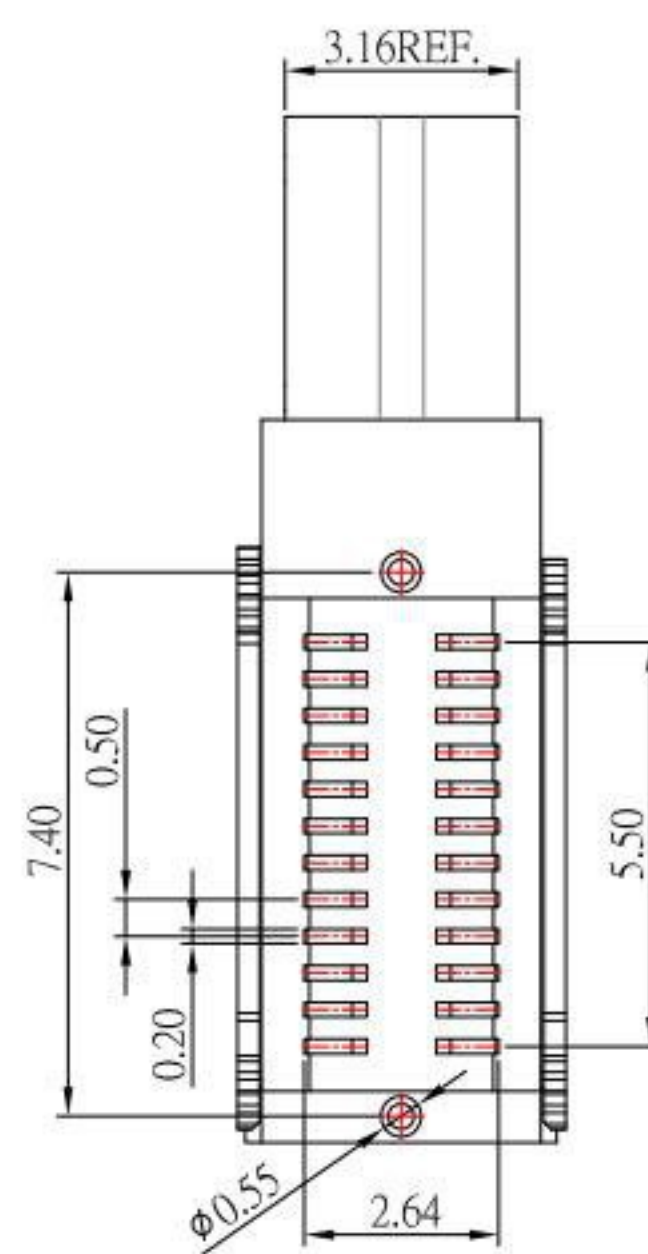
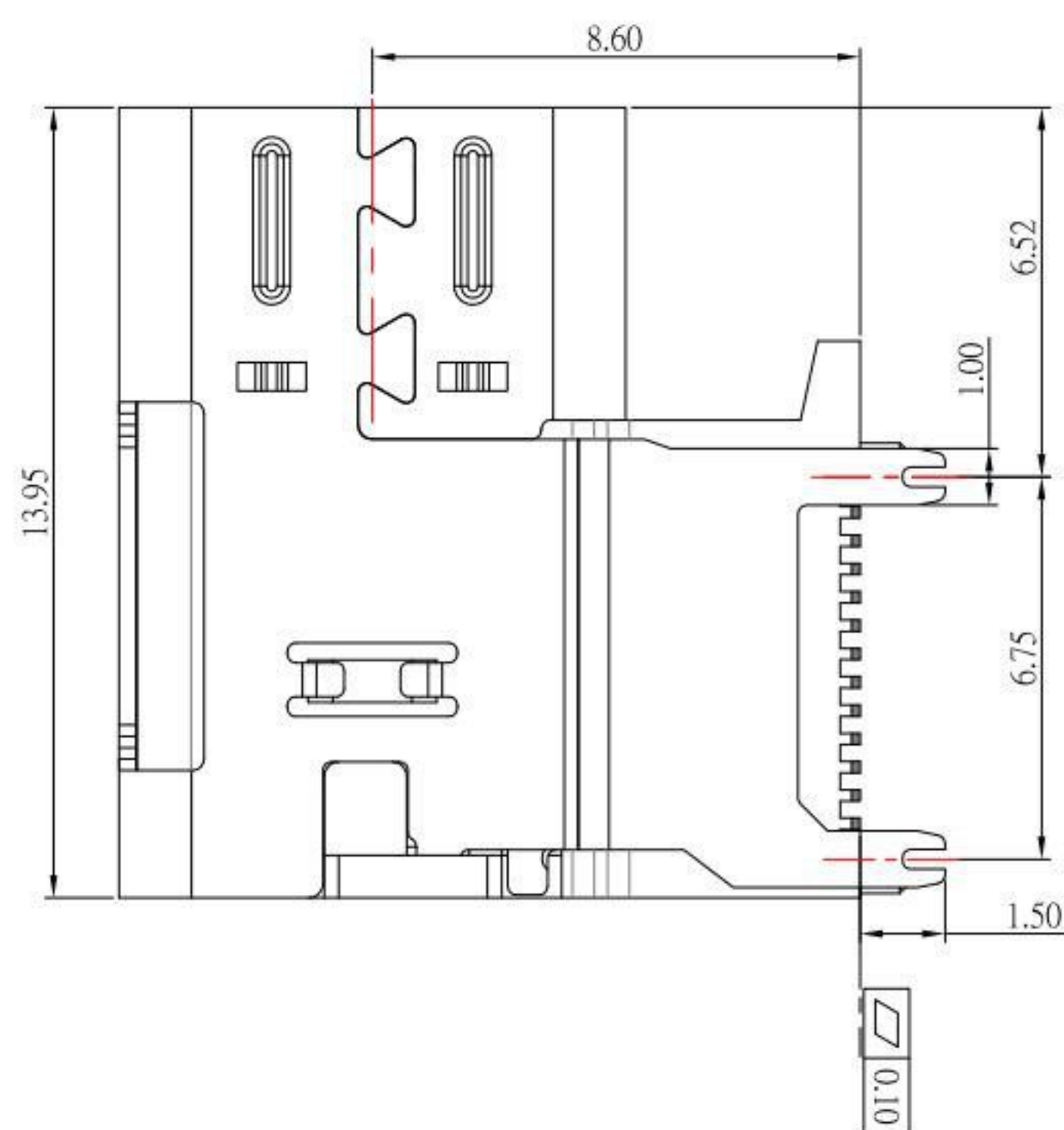

剖視圖

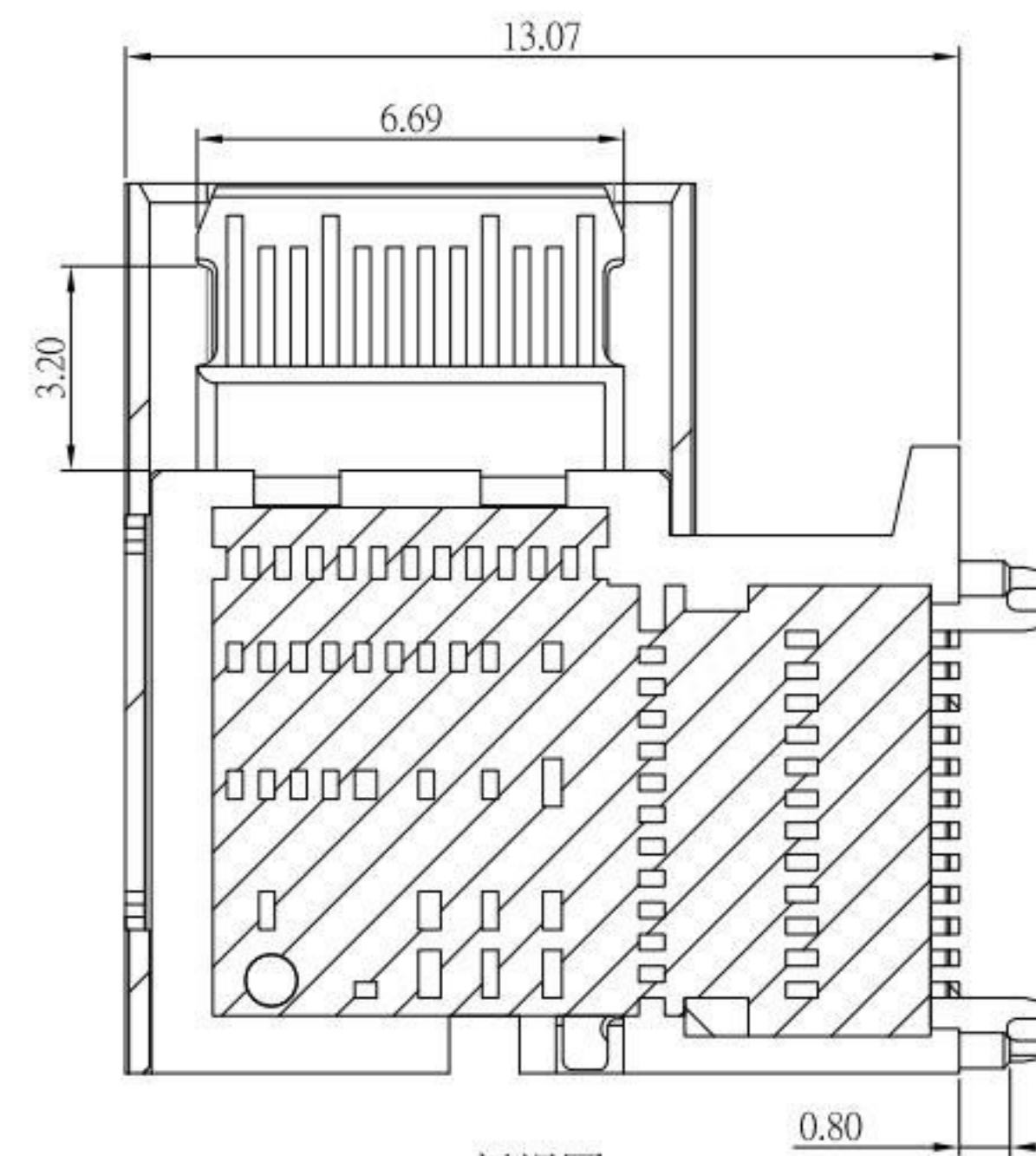

## P.C.B LAYOUT MOUNTING PATTERN

## SPECIFICATIONS

### Electrical:

1. Rating: 5.0A
2. Contact Resistance: 40 mΩ Max
3. Insulation Resistance: 100 MΩ Min
4. Withstanding Voltage: 150V AC

### Material:

1. Housing: LCP
2. Contact: C7025
3. Shell: SUS

### Finish:

1. Contact: Plated Gold in Mating Area ;  
Gold Plated on Solder Balls ;  
Nickel under plated overall
2. Shell: Nickel under Plated surface layer

### USB TYPE-C PIN ASSIGNMENTS

PIN NUMBER	SIGNAL NAME	PIN NUMBER	SIGNAL NAME
A1	GND	B12	GND
A2	SSTXp1	B11	SSRXp1
A3	SSTXn1	B10	SSRXn1
A4	Vbus	B9	Vbus
A5	CC1	B8	SBU2
A6	D+	B7	D-
A7	D-	B6	D+
A8	SBU1	B5	CC2
A9	Vbus	B4	Vbus
A10	SSRXn2	B3	SSTXn2
A11	SSRXp2	B2	SSTXp2
A12	GND	B1	GND

**KSD** 科斯达电子科技有限公司  
 SWITCH CONNECTOR KSD ELECTRONIC TECHNOLOGY Co., LTD  
 全球 互联零组件制造企业

TOLERANCE UNLESS OTHERWISE STATED:  
 Up to 5 ±0.2  
 Above 5 ~ 15 ±0.3  
 Above 15 ~ 30 ±0.4  
 Above 30 ~ 50 ±0.5  
 Angle ±0.3°

3RD. ANGEL'S

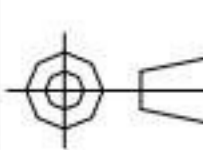

UNITS MM

DRAWN BY: Jack Lu  
 CHECKED BY: Jacky Chen  
 APPROVED BY: Tony Kao

DATE: 02/23/23  
 DATE: 02/23/23  
 DATE: 02/23/23

MAT'L  
 FINISH  
 SCALE: 1:1  
 SHEET NO. 1 of 1

TITLE: CONNECTOR  
 MODLE: USB 3.1 TYPE C 24PIN 側貼CH8.6 SMT  
 DWG NO.: SBC-240P2-31x-S412  
 PART NO.: SBC-240P2-31x-S412

SIZE: A4  
 VER: R

ITEM NO.	DESCRIPTION	DRAWN	DATE