

How to mate and unmate
Mate: ① - ② - ③
Unmate: ④

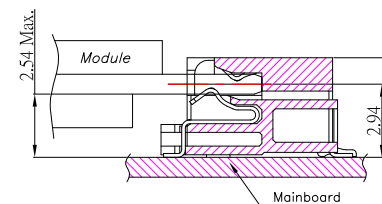

NGF-40S1B-xx-S273

鍍層厚度 :

COLOR :

Blank : 1u"
2 : 15u"
3 : 30u"

Black: B
White : W

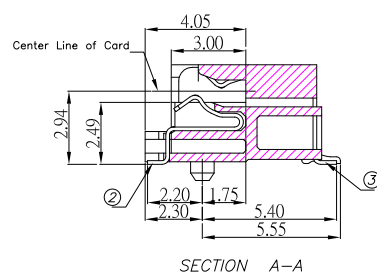
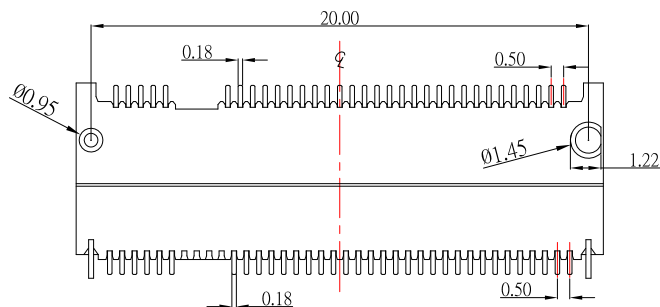
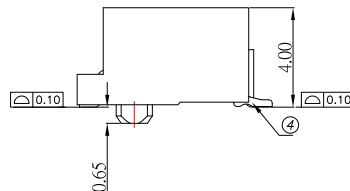
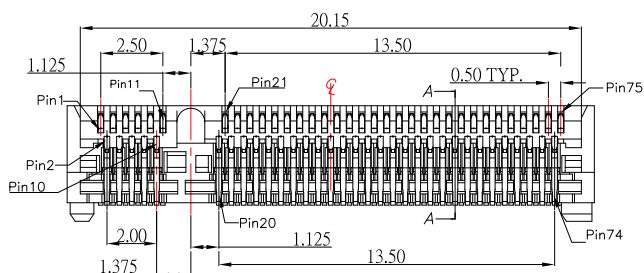

1.SPECIFICATION:

- 1.1 Current Rate: 0.5 A
- 1.2 Voltage Rate: 50V AC
- 1.3 Insulator Resistance: 500 MΩ Min
- 1.4 Dielectric Strength: 300V AC
- 1.5 Contact Resistance: 20mΩ Max
- 1.6 Mating Force: 20N Max
- 1.7 Unmating Force: 20N Max

2.MATERIAL:

- 2.1 Housing: LCP,UL94V-0
- 2.2 Contact: Phosphor Bronze
- 2.3 Leg: Brass

3.Finish:

- 3.1 Contact: Plated Gold in Mating Area ;
Tin Plated on Solder Balls ;
Nickel under plated overall
- 3.2 Leg: Tin Plated on Solder Balls
Nickel under plated overall



TOLERANCE UNLESS OTHERWISE STATED :

Up to 5 ±0.2
Above 5 ~ 15 ±0.3
Above 15 ~ 30 ±0.4
Above 30 ~ 50 ±0.5
Angle ±0.3°

3RD. ANGEL'S



UNITS MM

DRAWN BY: Jack Lu
CHECKED BY: Jacky Chen
APPROVED BY: Tony Kao
DATE: 05/04/16
DATE: 05/04/16
DATE: 05/04/16

MAT'L		TITLE	CONNECTOR
FINISH		MODLE	NGFF SOCKET 板上4.0H 正向 B KEY
SCALE	1 : 1	DWG NO.	NGF-40S1B-xx-S273
SHEET NO.	1 of 2	PART NO.	NGF-40S1B-xx-S273
		SIZE	A4
		VER	R1

1	更新料號及MODLE	Jack	050416
ITEM NO.	DESCRIPTION	DRAWN	DATE

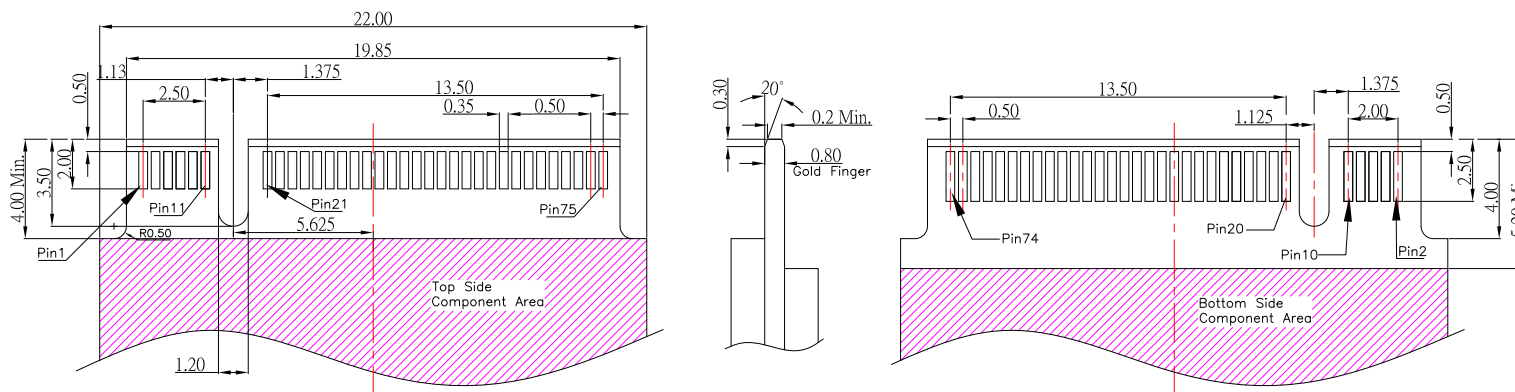

Recommended Mould Finger Layout

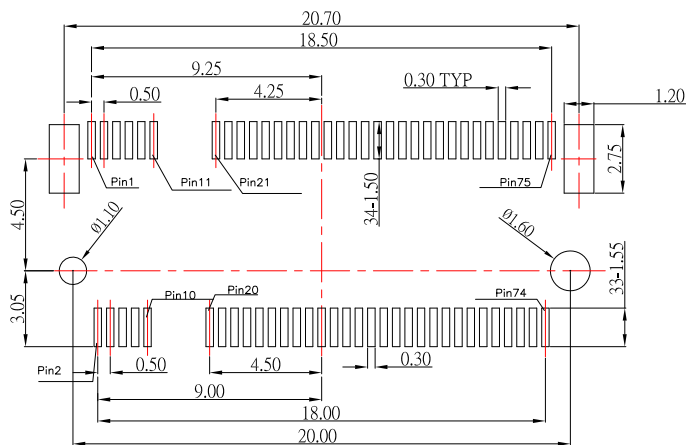

Recommended PCB Layout(Top View)

 **广东科斯达电子科技有限公司**
GUANG DONG KE SI DA ELECTRONIC TECHNOLOGY CO., LTD.

TOLERANCE UNLESS OTHERWISE STATED:
 Up to 5 ±0.2
 Above 5 ~ 15 ±0.3
 Above 15 ~ 30 ±0.4
 Above 30 ~ 50 ±0.5
 Angle ±0.3°

3RD. ANGEL'S



UNITS

MM

DRAWN BY:	DATE	MAT'L	TITLE	CONNECTOR
Jack Lu	05/04/16		MODLE	NGFF SOCKET 板上4.0H 正向 B KEY
CHECKED BY:	DATE	FINISH	DWG NO.	NGF-40S1B-xx-S273
Jacky Chen	05/04/16		PART NO.	NGF-40S1B-xx-S273
APPROVED BY:	DATE	SCALE	SHEET NO.	SIZE
Tony Kao	05/04/16	1 : 1	2 of 2	A4
				VER
				R1

1	更新料號及MODLE	Jack	050416
ITEM NO.	DESCRIPTION	DRAWN	DATE